

61668-1 ✓ ACTIVE

AMPMODU | UTILUX CR

TE Internal #: 61668-1

Connector Contact, Hermaphroditic, Wire-to-Board, Tin-Lead, 24 – 18 AWG Wire Size, .2 – .8 mm² Wire Size, Straight, Wire & Cable, 6 A, UTILUX CR

[View on TE.com >](#)



Connectors > PCB Connectors > Board-to-Board Connectors > Board-to-Board Connector Contacts

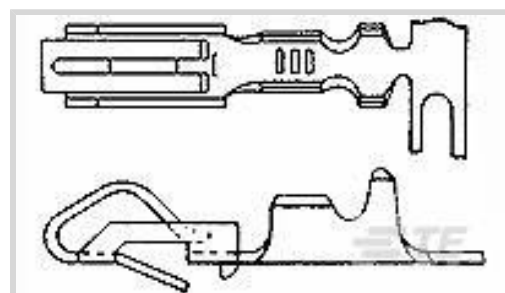

Contact Type: **Hermaphroditic**

Connector System: **Wire-to-Board**

Contact Mating Area Plating Material: **Tin-Lead**

Wire Size: **.2 – .8 mm²**

Features

Product Type Features

Connector System	Wire-to-Board
Connector & Contact Terminates To	Wire & Cable

Contact Features

PCB Contact Termination Area Plating Material Thickness	2.032 – 5.08 µm[80 – 200 µin]
Contact Mating Area Plating Material Thickness	2.032 – 5.08 µm[80 – 200 µin]
Contact Underplating Material	Nickel
PCB Contact Termination Area Plating Material	Tin-Lead
Contact Base Material	Brass
Contact Type	Hermaphroditic
Contact Mating Area Plating Material	Tin-Lead
Contact Orientation	Straight
Contact Current Rating (Max)	6 A

Termination Features

Termination Method to Wire & Cable	Crimp
------------------------------------	-------

Mechanical Attachment

Contact Retention Type Within Housing	Snap-In
Wire Insulation Support	With
PCB Mount Retention	Without
Connector Mounting Type	Board Mount



Dimensions

Accepts Wire Insulation Diameter Range	2.79 mm[.11 in]
Wire Size	.2 – .8 mm ²

Usage Conditions

Operating Temperature Range	-55 – 105 °C[-55 – 105 °F]
-----------------------------	----------------------------

Operation/Application

Circuit Application	Signal
---------------------	--------

Packaging Features

Packaging Quantity	6000
Packaging Method	Reel

Product Compliance

For compliance documentation, visit the product page on [TE.com](https://www.te.com)>

EU RoHS Directive 2011/65/EU	Not Compliant
EU ELV Directive 2000/53/EC	Compliant with Exemptions
China RoHS 2 Directive MIIT Order No 32, 2016	Restricted Materials Above Threshold
EU REACH Regulation (EC) No. 1907/2006	Current ECHA Candidate List: JUNE 2022 (224) Candidate List Declared Against: JUNE 2022 (224) SVHC > Threshold: Pb (13% in Component Part) Article Safe Usage Statements: Do not eat, drink or smoke when using this product. Wash thoroughly after handling. Recycle if possible and dispose of the article by following all applicable governmental regulations relevant to your geographic location.
Halogen Content	Low Halogen - Br, Cl, F, I < 900 ppm per homogenous material. Also BFR/CFR/PVC Free
Solder Process Capability	Not lead free process capable

Product Compliance Disclaimer

This information is provided based on reasonable inquiry of our suppliers and represents our current actual knowledge based on the information they provided. This information is subject to change. The part numbers that TE has identified as EU RoHS compliant have a maximum concentration of 0.1% by weight in homogenous materials for lead, hexavalent chromium, mercury, PBB, PBDE, DBP, BBP, DEHP, DIBP, and 0.01% for cadmium, or qualify for an exemption to these limits as defined in the Annexes of Directive 2011/65/EU (RoHS2). Finished electrical and electronic equipment products will be CE marked as required by Directive 2011/65/EU. Components may not be CE marked. Additionally, the part numbers that TE has identified as EU ELV compliant have a maximum concentration of 0.1% by weight in homogenous materials for lead, hexavalent chromium, and mercury, and 0.01% for cadmium, or qualify for an exemption to these limits as defined in the Annexes of Directive 2000/53/EC (ELV). Regarding the REACH Regulation, the information TE provides on SVHC in articles for this part number is based on the latest European Chemicals Agency (ECHA) 'Guidance on requirements for substances in articles' posted at this URL: <https://echa.europa.eu/guidance-documents/guidance-on-reach>

Compatible Parts

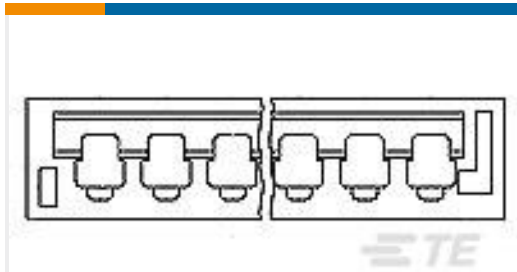

TE Part # 640136-2
02P EDGE CONN HSG, BIF-LEAF



TE Part # 58614-1
PROCRIMP, HT&D SL156



TE Part # 2305570-1
Strip Terminal Cutter-Side Feed-No Crimp

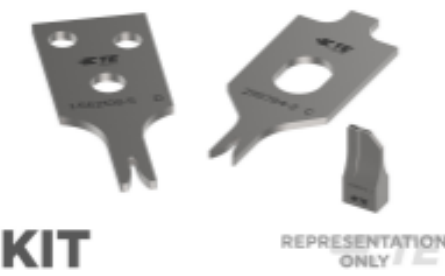

TE Part # 7-2151033-7
OCEAN_2.0_SPARE_PART_KIT-070F100F



TE Part # 2151033-1
OCEAN-2.0-APPLICATOR-S-070F100F

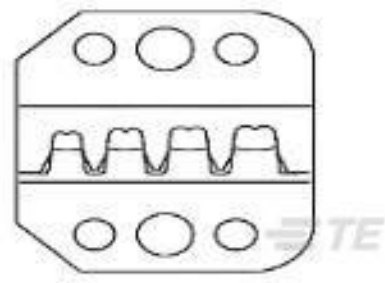

TE Part # 58614-2
PROCRIMP, DIE, SL156



TE Part # 91597-1
CCII SL-156 REC 24-18 ASSY



TE Part # 2-2151033-1
OCEAN-2.0-APPLICATOR-S-070F100F



TE Part # 2-2151033-2
OCEAN-2.0-APPLICATOR-S-070F100FA



TE Part # 2151033-2
OCEAN-2.0-APPLICATOR-S-070F100FA



TE Part # 5-2151033-1
OCEAN-2.0-APPLICATOR-S-070F100F



TE Part # 5-2151033-2
OCEAN-2.0-APPLICATOR-S-070F100FA

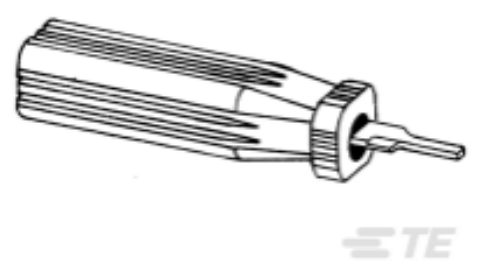

TE Part # 693597-2
EXTRACTION TOOL



TE Part # 7-2151033-1
OCEAN-2.0-APPLICATOR-S-070F100F

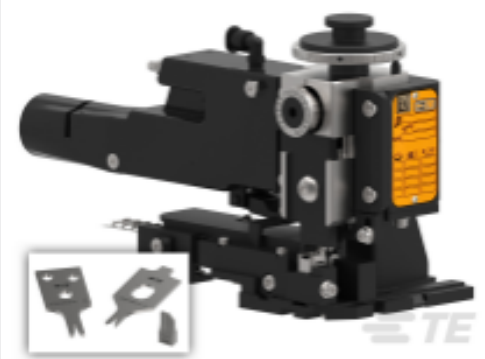

TE Part # 7-2151033-2
OCEAN-2.0-APPLICATOR-S-070F100FA

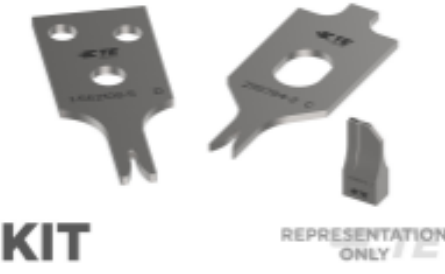

TE Part # 7-2266602-7
OCEAN_2.0_SPARE_PART_KIT-070F100F

Also in the Series | **UTILUX CR**



Board-to-Board Connector Contacts(4)



Card Edge Connector Housings(1)



Compression Connectors(7)



Insertion & Extraction Tools(1)



Wire-to-Board Connector Contacts(2)

Documents

Product Drawings

BIF-LEAF CONT CR/SNAP SNPB/BR

English

CAD Files

Customer View Model

[ENG_CVM_61668-1_AS.3d_igs.zip](#)

English

Customer View Model

[ENG_CVM_61668-1_AS.3d_stp.zip](#)

English

Customer View Model

[ENG_CVM_61668-1_AS.2d_dxf.zip](#)

English

3D PDF

English

By downloading the CAD file I accept and agree to the [Terms and Conditions](#) of use.

Product Specifications

Bifurcated Leaf Contact

English

Application Specification

English

Product Environmental Compliance

[MD_61668-1_112320122250](#)

English

61668-1

Connector Contact, Hermaphroditic, Wire-to-Board, Tin-Lead, 24 – 18 AWG Wire Size, .2 – .8 mm² Wire Size, Straight, Wire & Cable, 6 A, UTILUX CR



[MD_61668-1_112320122250](#)

English